

PergoLINE

RETRACTABLE PERGOLA SYSTEMS

PASSION for
OUTDOOR
LIVING



www.pergoline.com

2018

PASSION for
OUTDOOR
LIVING

CONTENTS

03	About Us	21	Sapphire Plus	41	Amethyst Park System
05	Bronze	25	Shell	45	Emerald
09	Gold	29	Shell Plus	48	Structure Colors
13	Diamond	33	Pearl	49	Fabric Colors
17	Sapphire	37	Pearl Plus	51	Our Documents

About Us

Byart Group is a leading institution in Turkey in project-design, manufacturing-applications, assembly-service of awnings and sun blinds with 30 years of experince.

PergoLine produces comfortable and functional rail awning systems (motor arbour) that does not require construction permit and all collapsible, wieldy in four seasons. It conveys 40% of total capacity to mainly Europe, Turkic Republics, Middle East and African market.

PergoLine uses the material developed with the latest technology by leading manufacturers which is operating in international arena in its' all products. System designs, aluminum constructions and all accessories are designed in Italy and patented products. PVC based blackout membrane fabric is German Mehler brand, Sioen Belgium and the motor and the automation system is French Somfy brand.

PergoLine produces the latest awning technology in our country at the same time with Europe and creates comfortable spaces. It provides services in 7300 m² closed area with 74 expert staff. PergoLine, which is the most preferred company about service-guarentee, is the mover and shaker of the sector with nearly annual 1000 projects.

Capacity report of the company prepared by the Ministry of Indusrty in 2014 was assessed as "Excellent".

“

High-tech pergolas are turning seasonal outdoor places into year-round entertaining spaces.

”



Bronze

Byart Pergoline Pergola Systems are modern awning systems equipped with advanced technological features that allow you to use your living area for four seasons. The Bronze's pillar structure allows lateral areas to be covered with Vertiglass vertical automatic glass systems or heat-insulated fixed systems. In this way, the effects of adverse weather conditions are reduced and extended living spaces are created which can be used for many years. The Bronze, which can be opened up to 600 cm, is suitable for solutions in private residences or confined spaces.

Single Form	Max. width: 450 cm	Max. projection: 600 cm
Double Form	Max. width: 800 cm	Max. projection: 600 cm
Triple Form	Max. width: 1200 cm	Max. projection: 600 cm

COLORS

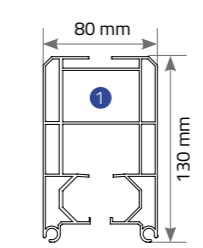
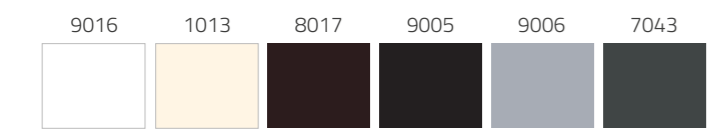

Rails

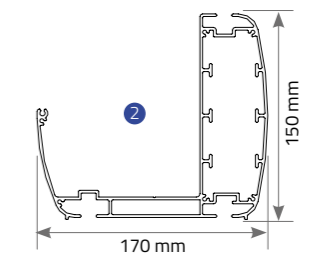

Extruded Frontal Gutter (Water-drain)

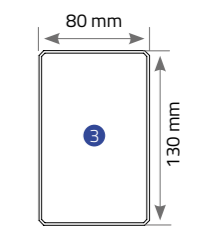

Pole



Bronze



Gold

Gold is an ergonomic and functional awning system with maximum opening up to 900 cm. It can open and close automatically and surrounds the desired area to be used in summer and winter conditions with its folded and railed features. The Gold Pergola Systems are aluminum and provides a suitable solution for workplaces with its pillar structure and wide opening. It is resistant to heavy weather conditions without the need for any extra carriers. Static measurements of the product have been performed. Since it can be closed with Vertiglass Automatic Glass Systems, a new living space can be created if needed.

Single Form Max. width: 450 cm Max. projection: 900 cm

Double Form Max. width: 800 cm Max. projection: 900 cm

Triple Form Max. width: 1200 cm Max. projection: 900 cm

COLORS

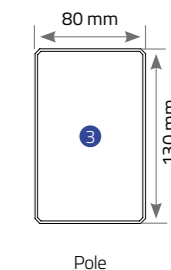
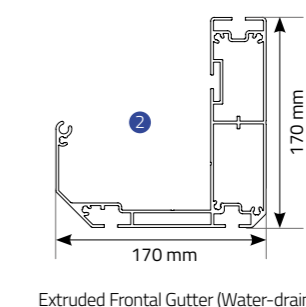
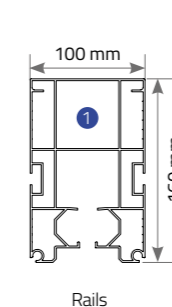
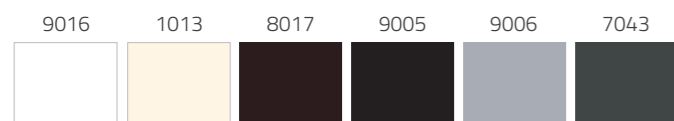



Gold

PergoLINE
RETRACTABLE PERGOLA SYSTEMS



Diamond

Diamond, which is one of Pergoline Pergola Systems' professional solutions, is a high technology awning system developed for large areas with a maximum opening up to 1200 cm without intermediate pillar. While it provides a shading service for large areas such as restaurants and hotels, Diamond is an innovative product with its central column-free, extra pillar-free feature. The product is resistant to the weights that it may encounter without the need of any support. Lateral areas can be closed with Vertiglass Automatic Glass Systems. In this way, open spaces can be easily converted to sheltered living spaces and winter gardens in line with the needs.

Single Form Max. width: 450 cm Max. projection: 1200 cm

Double Form Max. width: 800 cm Max. projection: 1200 cm

Triple Form Max. width: 1200 cm Max. projection: 1200 cm

COLORS

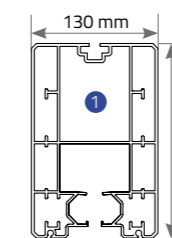
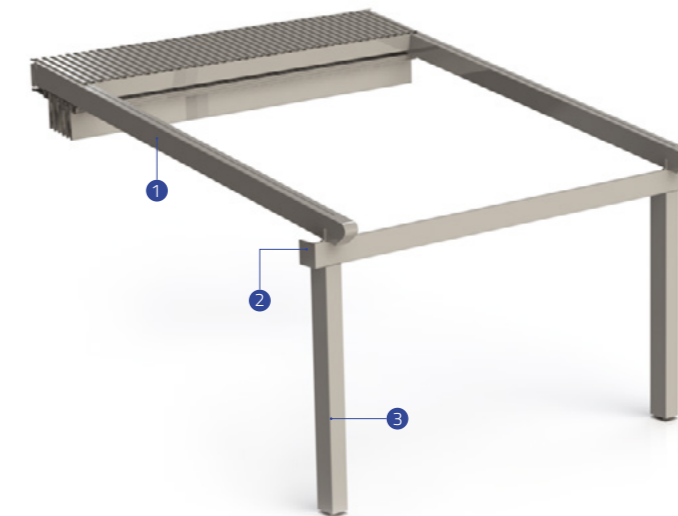
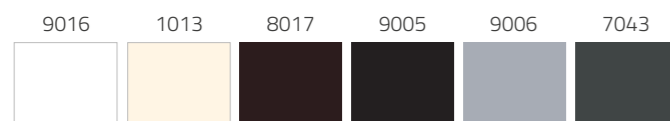

Rails

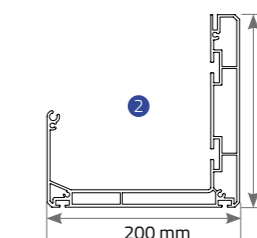

Extruded Frontal Gutter (Water-drain)

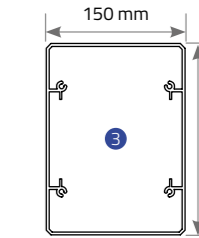

Pole



Diamond



Sapphire

Sapphire; is a suspensory and straight designed ergonomic awning system that is structured without pillars. The system, which opens and closes automatically, provides comfortable living spaces. It is a suitable system for residences with its structure opening up to 600 cm. The lack of connection with the ground is ideal for creating spacious solutions, especially in tight spaces. Aluminum system and epoxy polyester paint are used. With Sapphire, which is at the forefront of Byart quality and engineering, you will be protected from adverse weather conditions with a functional and modern design.

Single Form Max. width: 450 cm Max. projection: 600 cm

Double Form Max. width: 800 cm Max. projection: 600 cm

Triple Form Max. width: 1200 cm Max. projection: 600 cm

COLORS

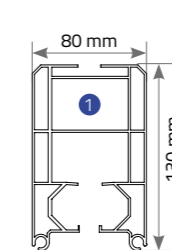
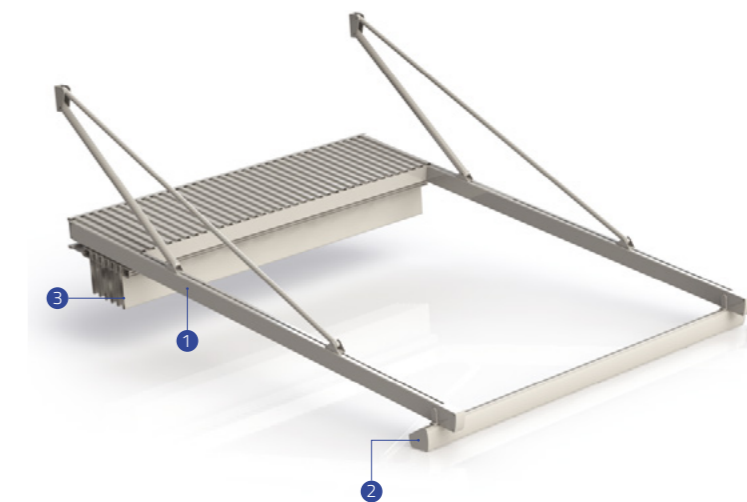
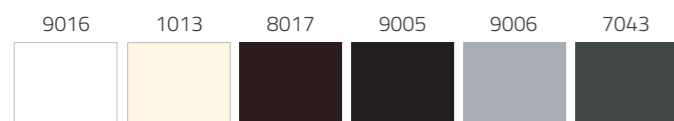

Rails

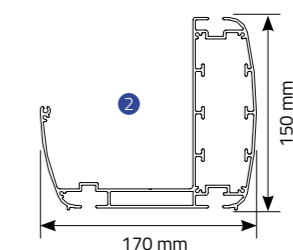

Extruded Frontal Gutter (Water-drain)

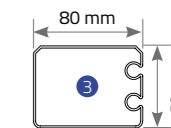

Last flowing profile



Sapphire



Sapphire Plus

Byart Pergoline Pergola Systems are modern awning systems equipped with advanced technological features that allow the comfortable and enjoyable use of living spaces. Sapphire Plus is designed as an curved shape, can be opened up to 600 cm; works in single, double and triple forms. The quality, which is one of the important details in the awning systems, is the distinguishing feature of Byart products. RTS technology used by world leader Somfy engines is guaranteed for 5 years. Sapphire Plus offers a suitable infrastructure for any kind of solution when a convenient lighting or a comfortable atmospheric environment is needed. This provides a comfortable solution for weather conditions while creating an airy and unobstructed environment for private residences or workplaces.

Single Form Max. width: 450 cm Max. projection: 600 cm

Double Form Max. width: 800 cm Max. projection: 600 cm

Triple Form Max. width: 1200 cm Max. projection: 600 cm

COLORS

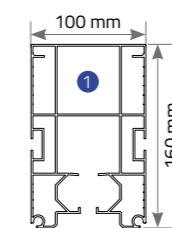
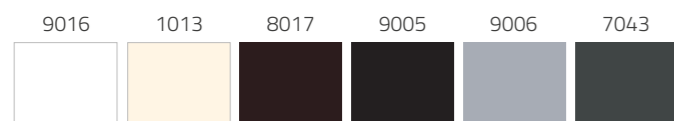

Rails

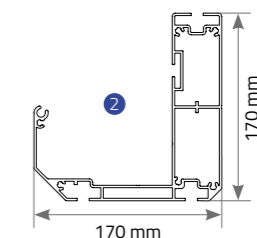

Extruded Frontal Gutter (Water-drain)

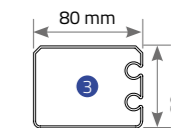

Last flowing profile

Sapphire Plus





Shell

Shell, which is equipped with Byart's state-of-the-art, superior quality awnings, can be with engine and control units in 2 or 3 front-pillar forms, depending on size and specifications. Its curved shape allows it adapting to any architectural aspects and a preferred choice for airy interior spaces. The maximum opening up to 900 cm and easy use without the need for building license make Shell a smart pergola system for comfortable spaces.

Single Form Max. width: 450 cm Max. projection: 900 cm

Double Form Max. width: 800 cm Max. projection: 900 cm

Triple Form Max. width: 1200 cm Max. projection: 900 cm

COLORS

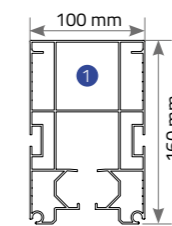
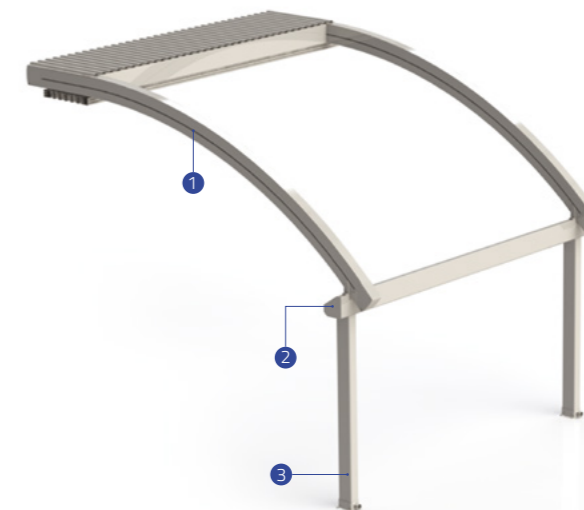
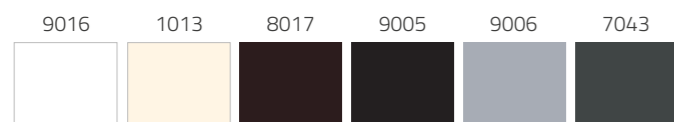

Rails

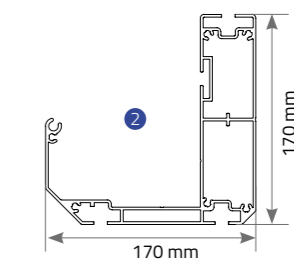

Extruded Frontal Gutter (Water-drain)

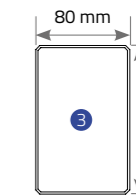

Pole



Shell



PergoLINE
RETRACTABLE PERGOLA SYSTEMS

Shell Plus

Shell Plus is suitable for large outdoor areas of professional businesses with its curved construction and opening up to 1000 cm. It is resistant to all weather conditions without requiring any additional carriers. Unprecedented use in a very large area is reserved by Shell Plus's advanced technology support. It is appropriate to cover the lateral areas with heat-insulated folding aluminum. Blackout dark fabrics used by Pergola Systems are distinguished sun protection, rain protection, wind resistance, non-flammability features, while and allow for functional solutions in the enterprises.

Single Form Max. width: 450 cm Max. projection: 1000 cm

Double Form Max. width: 800 cm Max. projection: 1000 cm

Triple Form Max. width: 1200 cm Max. projection: 1000 cm

COLORS

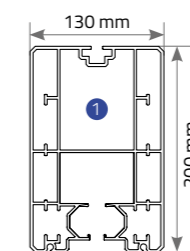
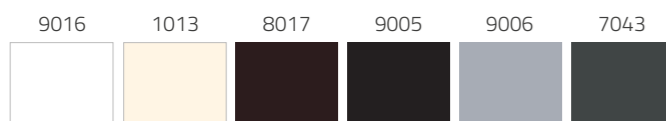

Rails

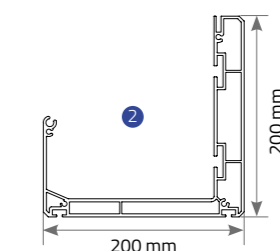

Extruded Frontal Gutter (Water-drain)

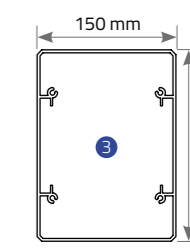

Pole



Shell Plus



Pearl

Pearl, which creates four season area of use without the need for building license in the outdoor solutions, stands on its own feet. It can be positioned independently without the need for any connection to the main building. With this important detail, the structure that can be opened up to 900 cm and the oval appearance meets many needs at the same time. It has a very wide use network such as independent winter gardens, lounges, workshops, restaurant gardens. It also offers convenient solutions with its folding structure. Side areas can be covered Vertiglass Automatic Glass Systems. It can be produced in single, double and triple form.

Single Form Max. width: 450 cm Max. projection: 900 cm

Double Form Max. width: 800 cm Max. projection: 900 cm

Triple Form Max. width: 1200 cm Max. projection: 900 cm

COLORS

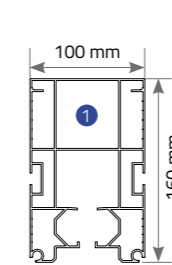
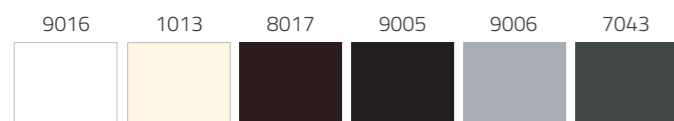

Rails

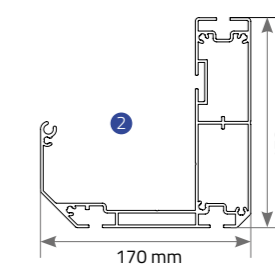

Extruded Frontal Gutter (Water-drain)

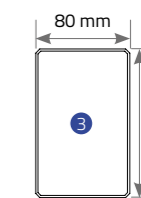

Pole





Pearl Plus

Pearl Plus is a key enable of open-air solutions in large areas with a maximum opening up to 1000 cm. It has a carrying capacity without the need for extra support against all kinds of adverse weather conditions. The static measurements of the product have been performed. It can be created in single, double or triple form and can be 1 or 2 engine system according to its size; and with remote control or control unit. Byart Pearl Plus is an ergonomic and functional and high-tech product that allows you to use the area that protects in summer and winter conditions.

Single Form	Max. width: 450 cm	Max. projection: 1000 cm
Double Form	Max. width: 800 cm	Max. projection: 1000 cm
Triple Form	Max. width: 1200 cm	Max. projection: 1000 cm

COLORS

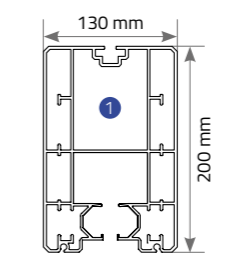
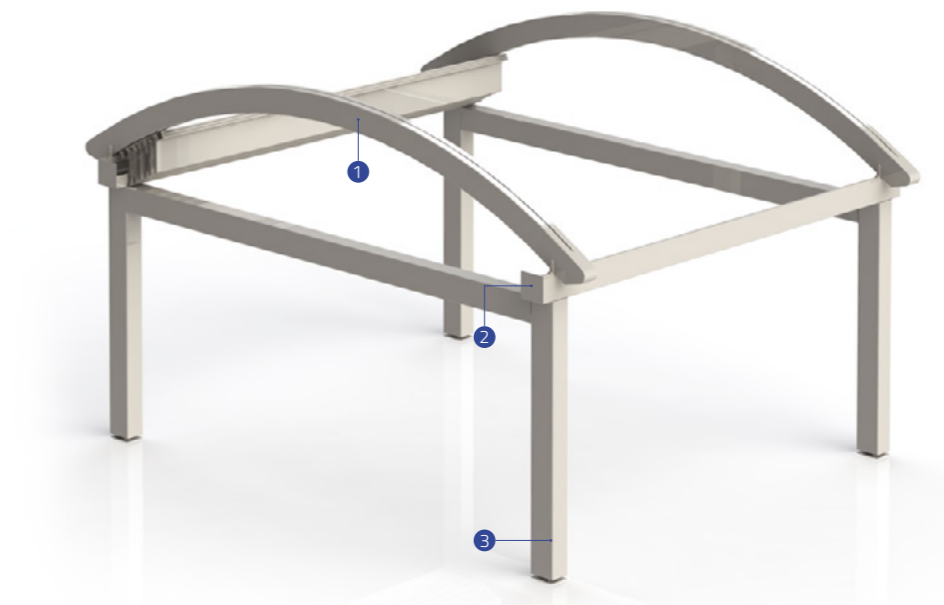
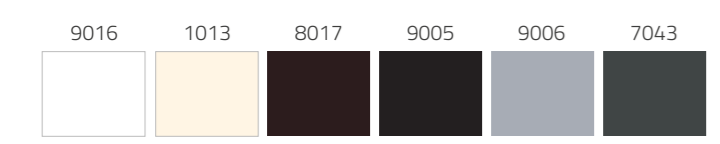

Rails

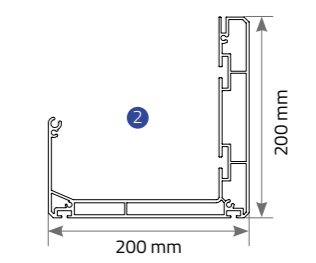

Extruded Frontal Gutter (Water-drain)

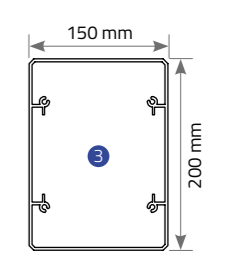

Pole



Pearl Plus



Amethyst Park System

Byart, which adopts modern and functional design as a principle, created the Amethyst Park System against the effects of adverse weather conditions on the vehicles. This ergonomic system, which is the parking solution of Byart's experience and quality, adapts four seasons of comfort to the new generation parking systems. It has a structure that can be opened up to 500 cm and provides a waterproof structure protected from sun and wind with its single, double and triple forms.

Single Form Max. width: 300 cm Max. projection: 500 cm

Double Form Max. width: 600 cm Max. projection: 500 cm

Triple Form Max. width: 900 cm Max. projection: 500 cm

COLORS

9016 1013 8017 9005 9006 7043

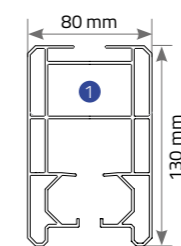
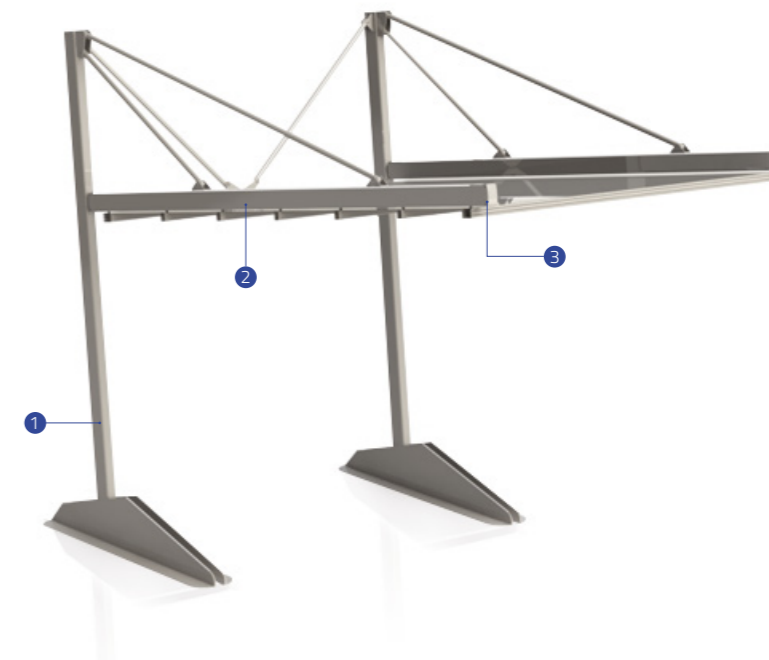

Rails

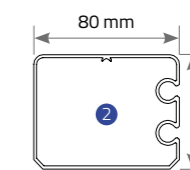

Last Flowing Profile

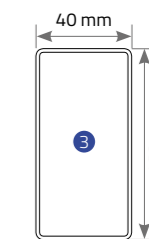

Pole

Amethyst Park System





Emerald

Emerald is an independent open-air solution on its own feet and brings together the modern strength and original qualities of the Byart design. It has the technology of preventing water accumulation with the hidden slope on the surface. It can be produced in single and double form, and the maximum opening is up to 800 cm. Blackout dark fabrics used by Pergola Systems are distinguished sun protection, rain protection, wind resistance; non-flammability features and allows creating comfortable living spaces.



Single Form	Max. width: 450 cm	Max. projection: 800 cm
Double Form	Max. width: 800 cm	Max. projection: 800 cm

COLORS

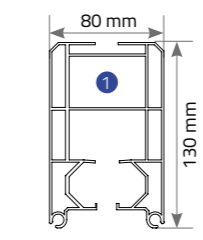
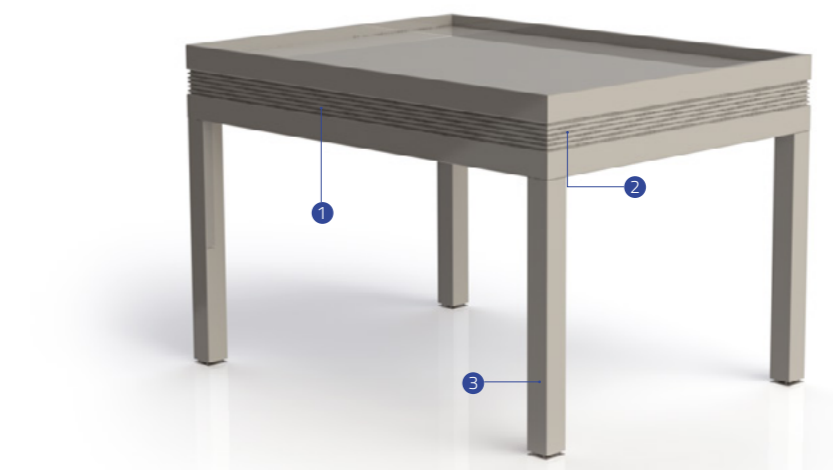
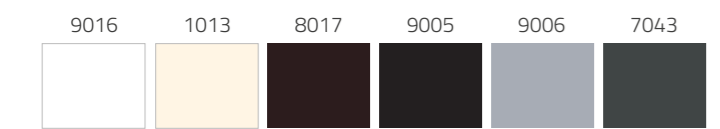

Rails

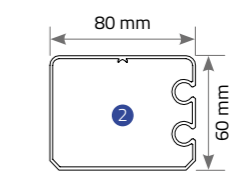

Last Flowing Profile

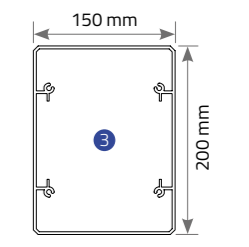

Pole



Emerald



Structure Colors

RAL

Colours are just approximate. For the correct colour refer to the RAL table.

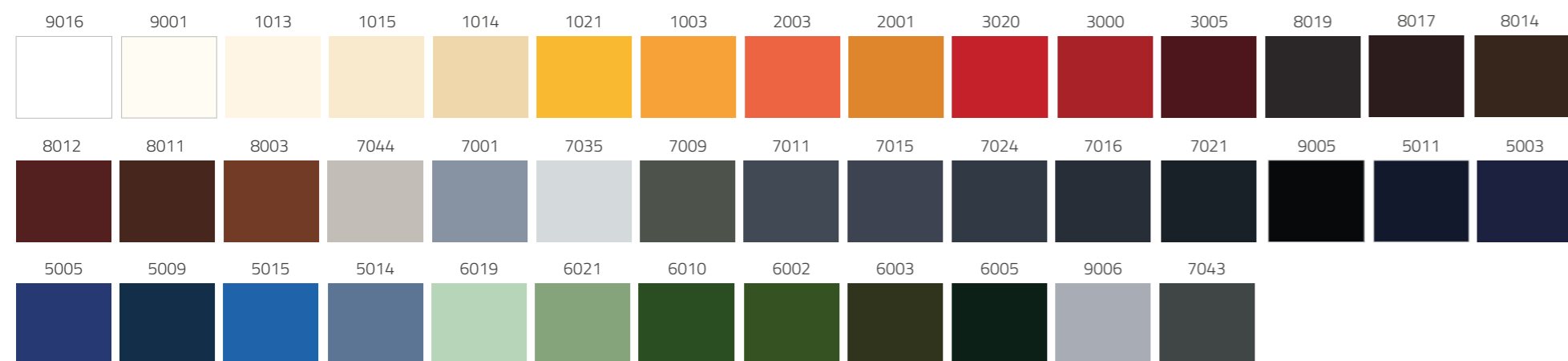

SPECIAL COLORS ÖZEL RENKLER



PergoLine gives possibility to choose among other European Ral colors. Ask for availability and price.

Fabric Colors



Our Documents



OUR PARTNERS



www.pergoline.com

PergoLINE
RETRACTABLE PERGOLA SYSTEMS
www.pergoline.com

Türkocağı Caddesi No: 46 / A-B Balgat - ANKARA/TURKEY

T: +90 (312) 285 39 00 ▪ F: +90 (312) 284 30 60

byart@byarttente.com

BYART[®]
GROUP
www.byartgroup.com